

Product Description

Consumer products, such as Set-Top boxes, PVR's, Home Gateways, and Cable Modems, often require a technique for "splitting" the incoming RF CATV signal, to perform various functions, such as picture-in-picture, VOIP, data, and video recording.

Sirenza Microdevices' CGA-0116 is a high performance 3-output broadband CATV active splitter-amplifier, designed for operation at 5V. It offers flat gain, high isolation, high IP2, and low power consumption.

This RFIC uses the latest Silicon Germanium Heterostructure Bipolar Transistor (SiGe HBT) process featuring 2 micron emitters.

The matte tin finish on Sirenza's lead-free package utilizes a post annealing process to mitigate tin whisker formation and is RoHS compliant per EU directive 2002/95. This package is also manufactured with green molding compounds that contain no antimony trioxide nor halogenated fire retardants.

Functional Block Diagram

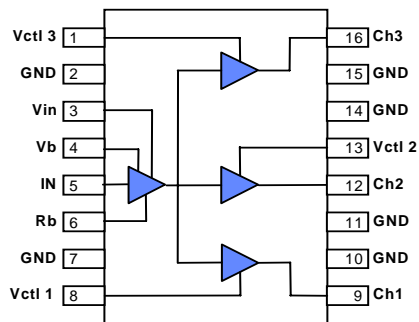

Key Specifications

Symbol	Parameters: Test Conditions $Z_0 = 75\Omega, V_{CC} = 5.0V, I = 150mA, T_{BP} = 30^\circ C$	Unit	Min.	Typ.	Max.
f_0	Frequency of Operation	MHz	50		870
I	Current		135	150	165
P_{1dB}	Output Power at 1dB Compression - Channels 1&2 @ 500MHz	dB μ V	114.5	116	
	Output Power at 1 dB Compression - Channel 3 @ 870MHz	dB μ V	118.5	120	
S_{21}	Small Signal Gain - Channels 1&2 @ 870MHz	dB	1.8	2.3	2.8
	Small Signal Gain - Channel 3 @ 870MHz	dB	6.5	7.5	8.5
IRL	Input Return Loss 50MHz to 870MHz	dB	7.5	9	
ORL	Output Return Loss 50MHz to 870MHz	dB	11	13	
OIP ₃	Output Third Order Intercept Point - Channels 1&2 @ 500MHz	dB μ V	127	129	
	Output Third Order Intercept Point - Channel 3 @ 500MHz	dB μ V	132	134	
OIP ₂	Output Second Order Intercept Point - Channels 1&2 @ 500MHz	dB μ V	146	149	
	Output Second Order Intercept Point - Channel 3 @ 500MHz	dB μ V	152	155	
NF	Noise Figure - Channels 1&2 @ 870MHz	dB		7.5	8.5
	Noise Figure - Channel 3 @ 870MHz	dB		7.5	8.5
S_{12}	Isolation, Channel-to-Channel 50MHz to 870MHz	dB	32	35	
	Isolation, Output-to-Input 50MHz to 870MHz	dB	37	40	
$R_{TH, jH}$	Thermal Resistance (junction - lead)	$^\circ C/W$		70	

CGA-0116

CGA-0116Z RoHS Compliant & Green Package

3-Output Active Splitter for CATV

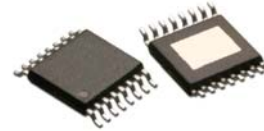

16 pin TSSOP Package with Exposed Ground Pad

Product Features

- Available in Lead Free, RoHS compliant, and Green packaging
- Broad Frequency Band: 50 to 870 MHz
- Flat Gain Response: $< \pm 0.5$ dB Variance
- Internally Matched to 75Ω
- High Isolation between Output Ports: >35 dB
- High IP2: >149 dB μ V
- Single Voltage Supply
- Patent Pending

Applications

- Set-top Box
- Cable Modem
- PVR

The information provided herein is believed to be reliable at press time. Sirenza Microdevices assumes no responsibility for inaccuracies or omissions. Sirenza Microdevices assumes no responsibility for the use of this information, and all such information shall be entirely at the user's own risk. Prices and specifications are subject to change without notice. No patent rights or licenses to any of the circuits described herein are implied or granted to any third party. Sirenza Microdevices does not authorize or warrant any Sirenza Microdevices product for use in life-support devices and/or systems. Copyright 2002 Sirenza Microdevices, Inc. All worldwide rights reserved.

Pin Out Description

Pin #	Function	Description
1	Vctl 3	Gain adjust for Output 3. This pin should be bypassed to ground for max gain
2,7,10 11,14, 15	GND	Connection to ground.
3	Vin	Voltage supply connection for input. This pin should be bypassed with a suitable capacitor.
4	Vb	Bias connection for input. This pin should be bypassed with a suitable capacitor
5	IN	RF input pin. This pin requires a DC blocking capacitor
6	Rb	Input bias resistor connection for setting bias current. This pin should be connected to ground for specified operation.
8	Vctl 1	Gain adjust for Output 3. This pin should be bypassed to ground for max gain
9	Ch. 1	RF Output 1 and DC supply pin. This pin required the use of an external blocking capacitor and RF choke.
12	Ch. 2	RF Output 2 and DC supply pin. This pin required the use of an external blocking capacitor and RF choke.
13	Vctl 2	Gain adjust for Output 3. This pin should be bypassed to ground for max gain
16	Ch. 3	RF Output 3 and DC supply pin. This pin required the use of an external blocking capacitor and RF choke.
Back-side	GND	The exposed backside paddle needs to be well grounded with multiple vias. This is the main electrical GND and the main thermal path.

Simplified Device Schematic

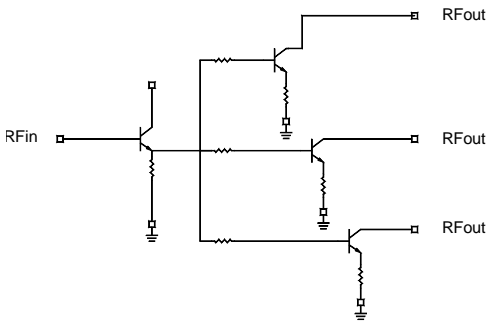

Absolute Maximum Ratings

Parameters	Value	Unit
Current	200	mA
Device Voltage (V _D)	6.0	V
Power Dissipation	1.2	W
Operating Lead Temperature (T _L)	-40 to +85	°C
RF Input Power	15	dBm
Storage Temperature Range	-40 to +150	°C
Operating Junction Temperature (T _J)	+150	°C

Operation of this device beyond any one of these limits may cause permanent damage. For reliable continuous operation the device voltage and current must not exceed the maximum operating values specified in the table on page one.

Bias conditions should also satisfy the following expression:
 $I_D V_D < (T_J - T_L) / R_{TH} \text{ } ^\circ\text{C/W}$



Caution: ESD Sensitive

Appropriate precaution in handling, packaging and testing devices must be observed.

Evaluation Board Data ($V_{CC} = 5.0V$, $I_{CC} = 150mA$)

Gain vs Frequency

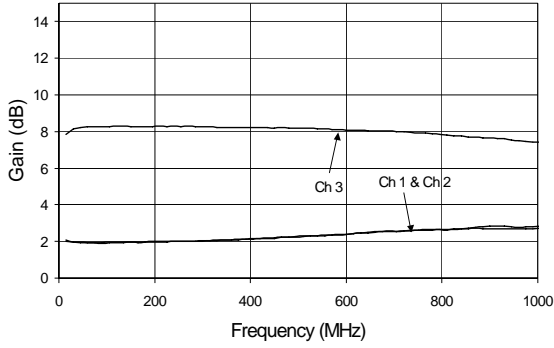

Input Return Loss Vs. Freq

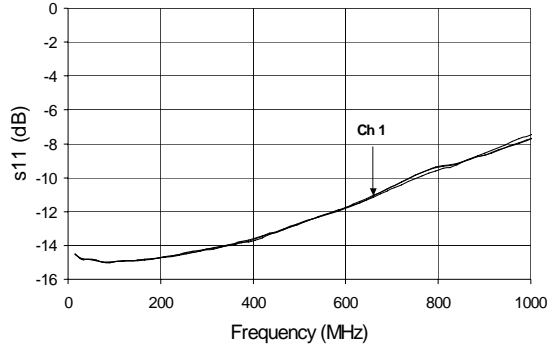

Output Return Loss vs Frequency

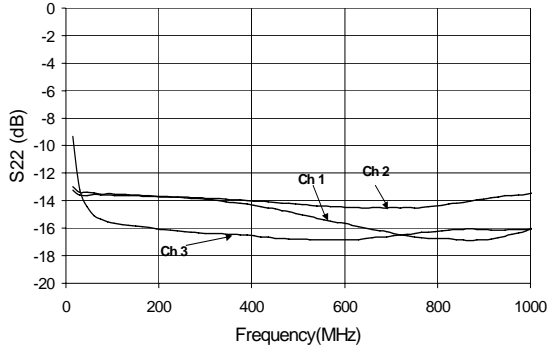

Isolation Channel Output to RF Input

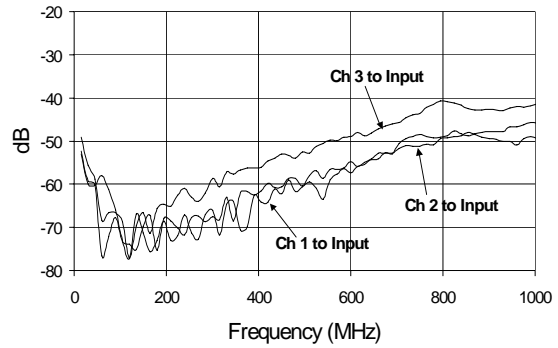

Isolation vs Frequency

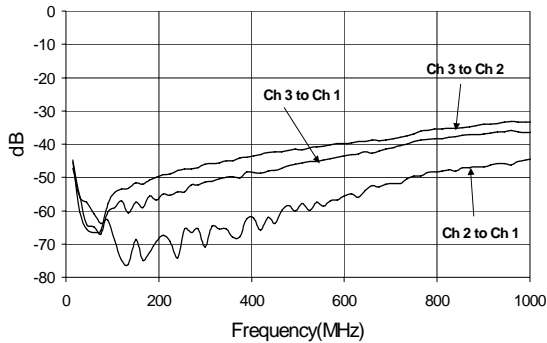

Noise Figure vs Frequency

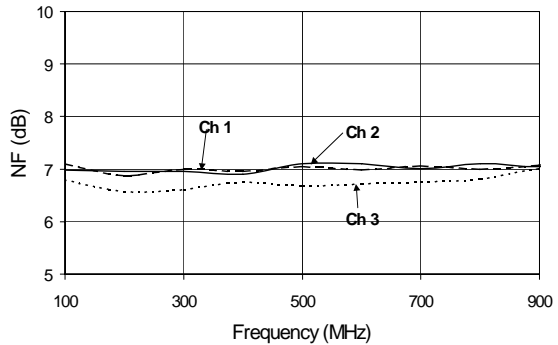

Evaluation Board Data ($V_{CC} = 5.0V$, $I_{CC} = 150mA$)

Channel 1 Gain vs Temperature

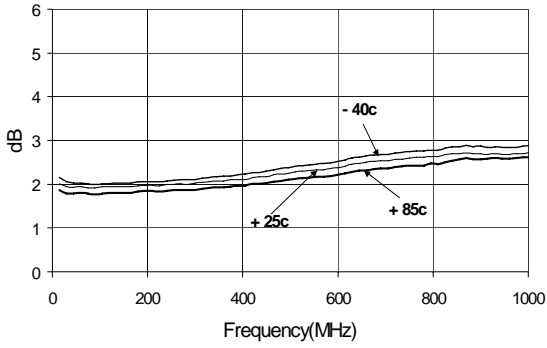

Channel 2 Gain vs Temperature

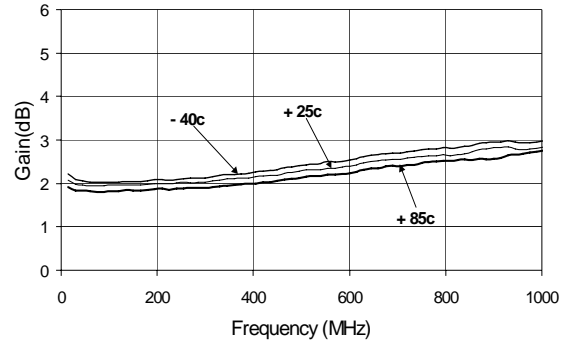

Ch 3 Gain vs Temperature

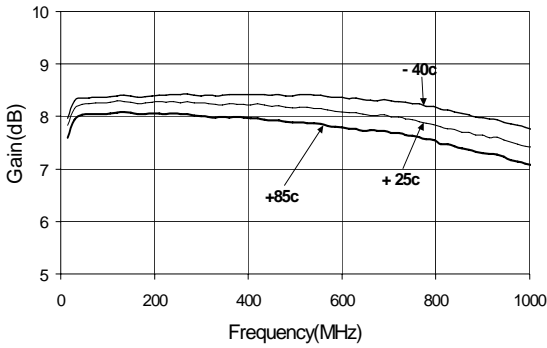

P1dB vs. Temperature (500 MHz)

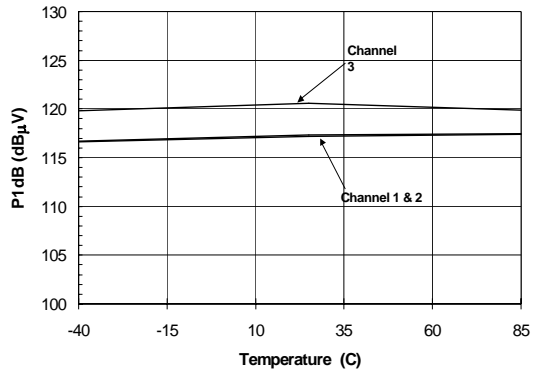

IP2 vs. Temperature (500 MHz)

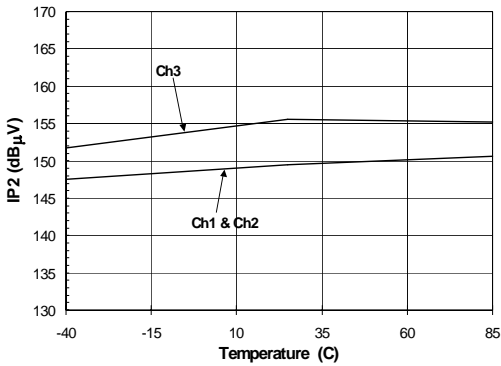

IP3 vs. Temperature (500 MHz)

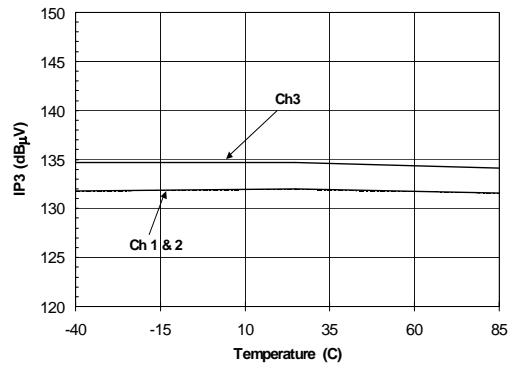

Channel 1 and 2 Composite Performance:
Evaluation Board Data ($V_{CC} = 5.0V$, $I_{CC} = 150mA$)

Ch. 1 Measured Data Shown

CTB/CSO/XMOD, Ch. 1 & 2
Input Power 76 dBuV/Ch., 100 Ch., Flat

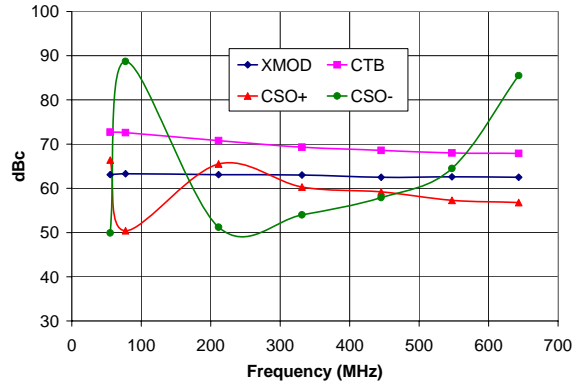

Channel 1 & 2 Composite Performance vs. Input Power Level, 100 Ch., Flat:

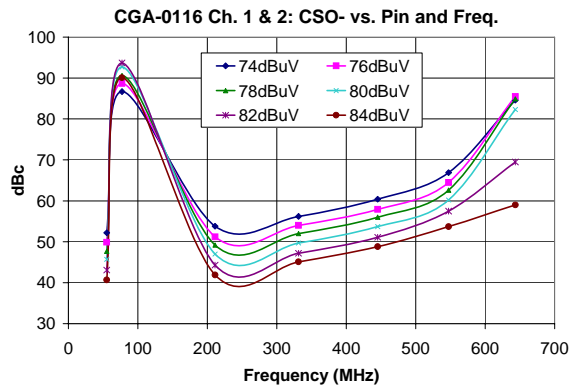
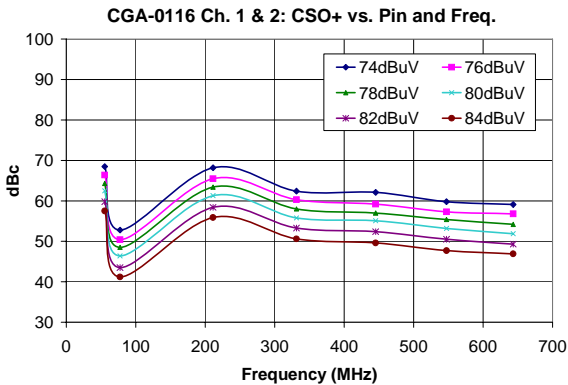
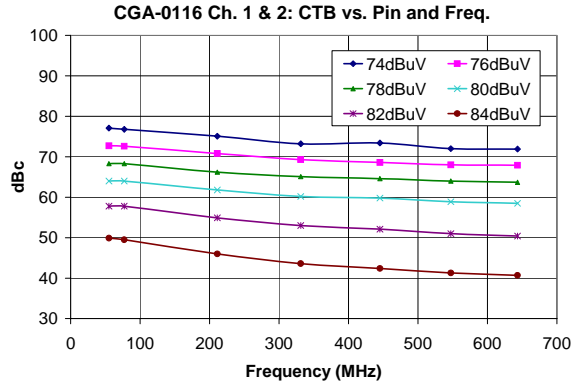
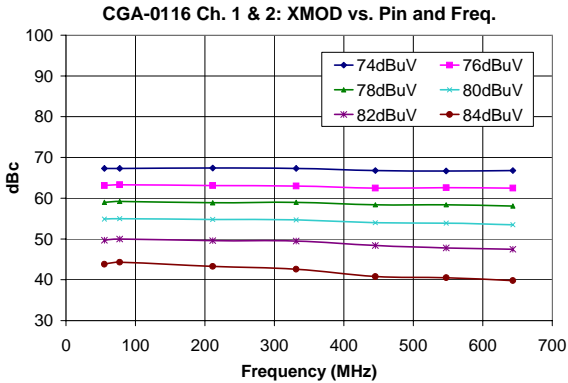

Channel 3 Composite Performance:

Evaluation Board Data ($V_{CC} = 5.0V$, $I_{CC} = 150mA$)

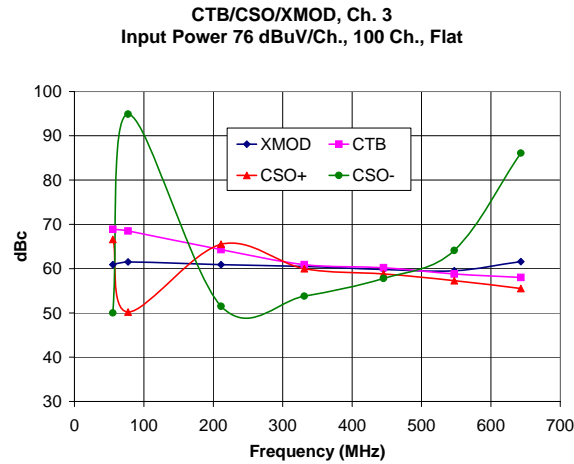

Channel 3 Composite Performance vs. Input Power Level, 100 Ch., Flat:

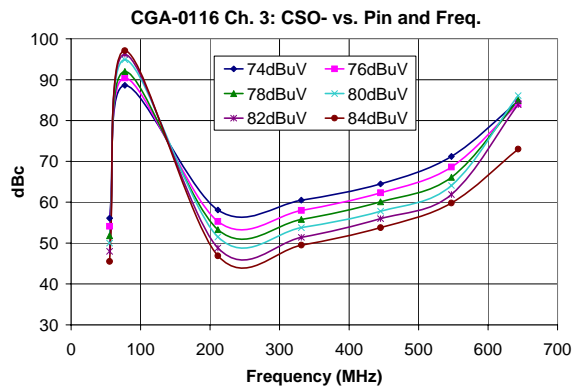
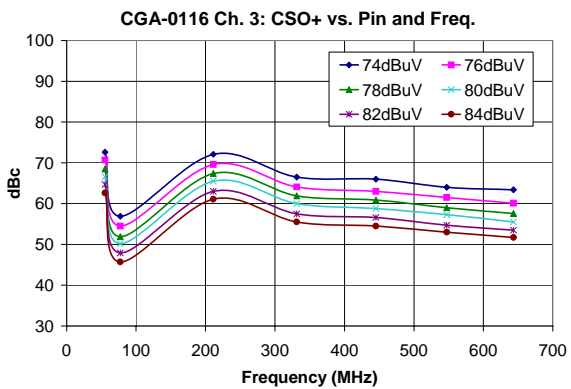
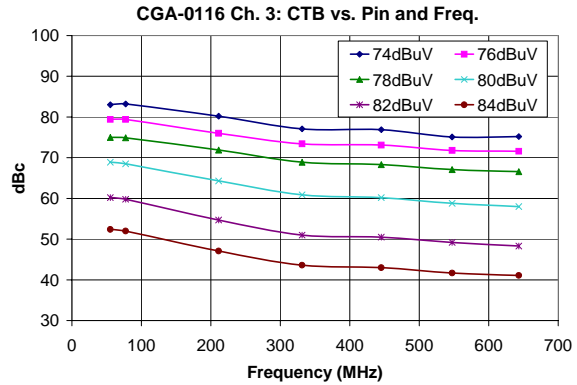
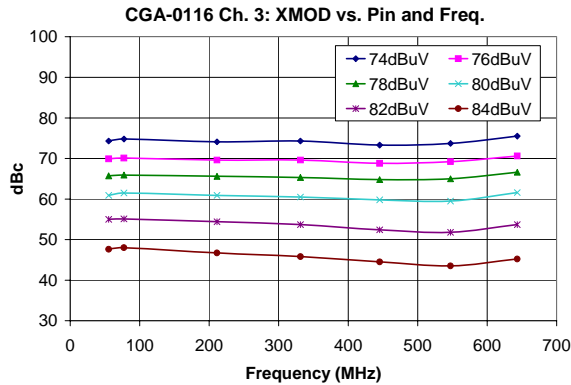

Evaluation Board Schematic

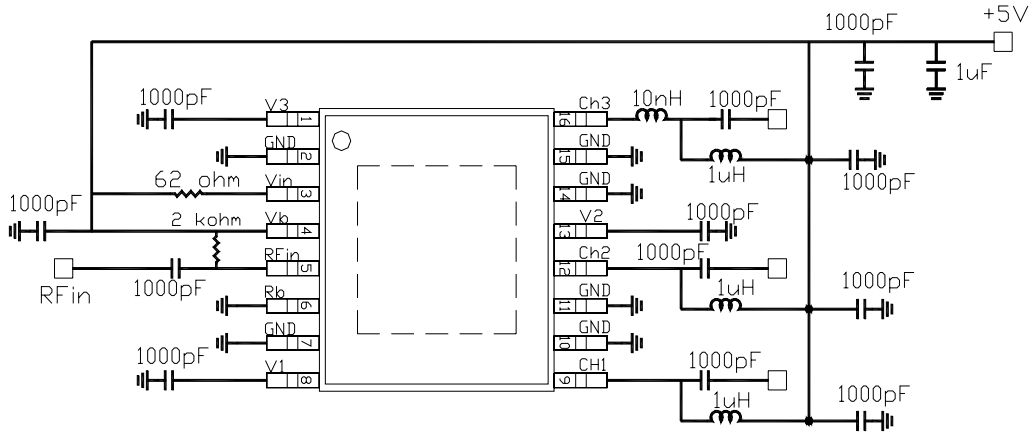

Evaluation Board Layout

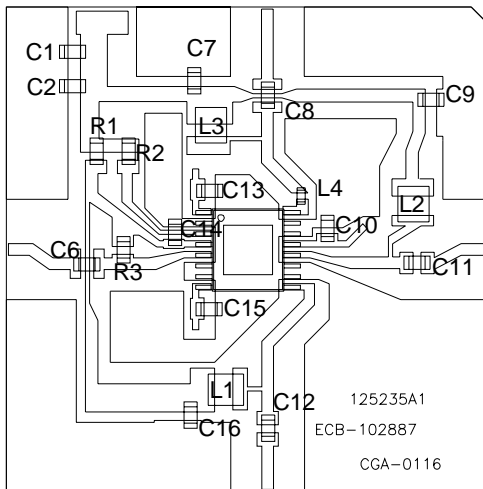

Component	Value
C1	0.1uF
C2,C6,C7,C8,C9,C10,C11, C12,C13,C14,C15,C16	1000pF
L1,L2,L3	1uH
R1	0 ohm
R2	62 ohm
R3	2K ohm
L4	10nH 0402 size

NOTE: VIAS NOT SHOWN

Package Outline Drawing

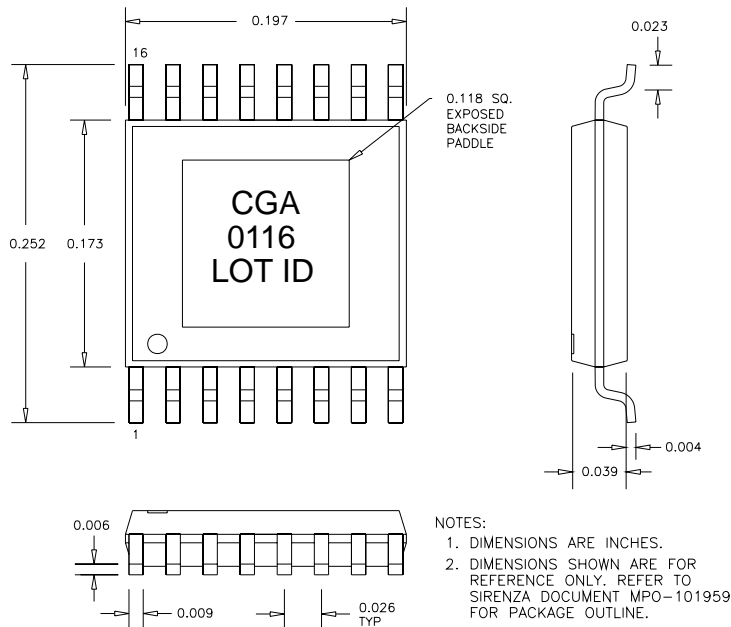

Recommended Land Pattern

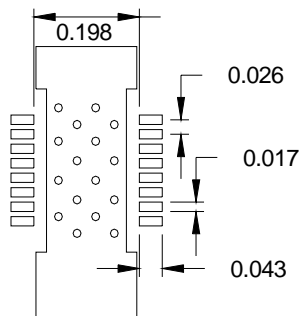

Note 1: Dimensions are in inches

Part Symbolization

The part will be symbolized with an "CGA-0116" marking designator on the top surface of the package.

Part Number Ordering Information

Part Number	Reel Size	Devices/Reel
CGA-0116	7"	1000
CGA-0116Z	7"	1000